

Dealer: _____ Date: _____ Quote Only
 Dealer PO

Attn: _____ Phone: _____ Fax: _____

SUNROOM and SKYWALLS

opening at wall

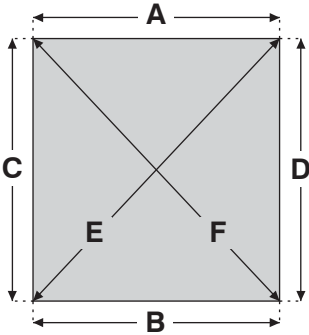

outside curb dimensions

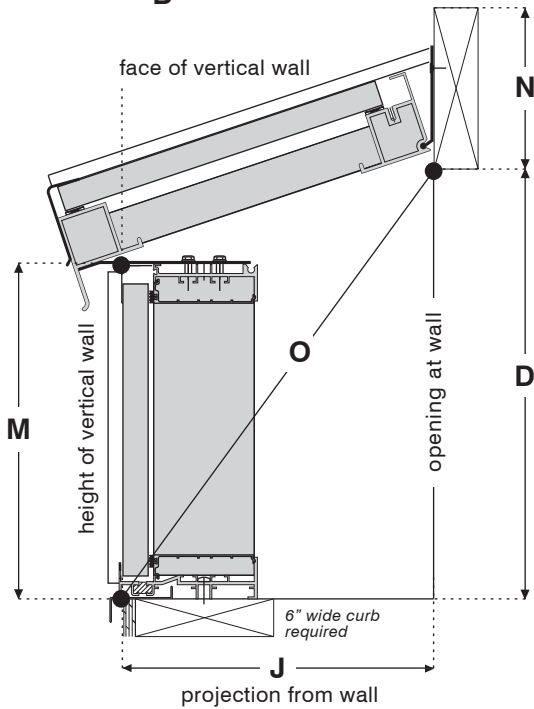
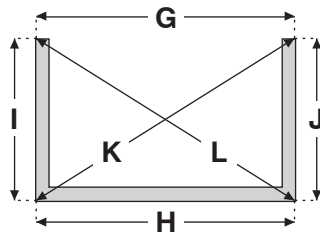

Number of Bays on Projection

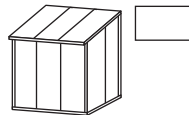

Number of Bays on Face



Minimum 2/12 pitch required for all glass & flat-glazed skylites.

	Opening of Wall
	inches
A	
B	
C	
D	
E	
F	
	Curb Footing
	inches
G	
H	
I	
J	
K	
L	
	Other Dimensions
	inches
M	
N	
O	
	Roof Pitch
	inches
	_____ " _____
	_____ " _____

Installation Situation

Standard

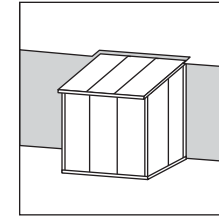

Corner w/ Roof Line

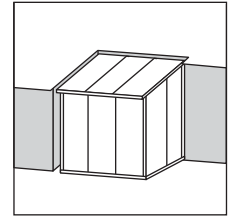

Use Page 1 for these Installations

Use Page 2 for these Installations

Corner

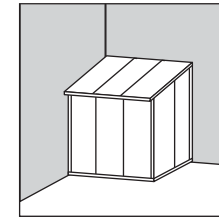

Skywall

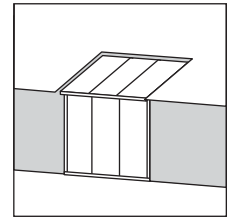

Vertical Glazing Type

Residential Commercial
Laminated or Polycarb. Glazing Required

Overhead Glazing Type

Residential Commercial
Laminated or Polycarb. Glazing Required



EVERETT
 phone: 1-800-666-6065
 fax: 425-258-6734

SPOKANE
 phone: 1-800-382-5403
 fax: 509-921-2137

SALEM
 phone: 1-800-664-1257
 fax: 503-391-0974

Dealer: _____ Date: _____ Quote Only Dealer PO

Attn: _____ Phone: _____ Fax: _____

SUNROOM and SKYWALLS

opening at wall

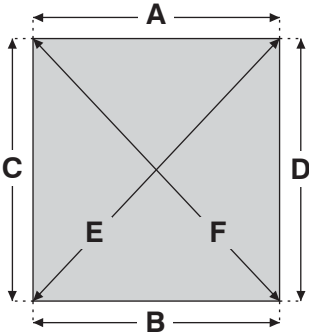

outside curb dimensions

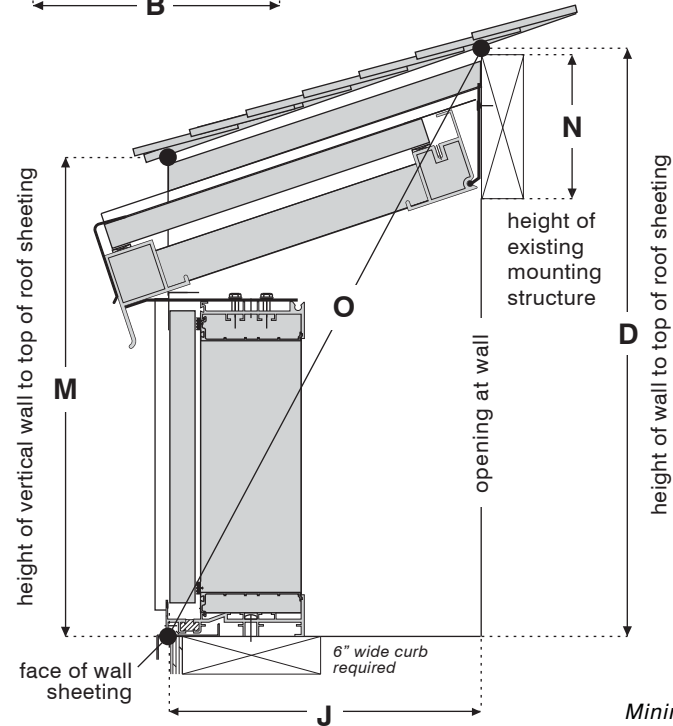
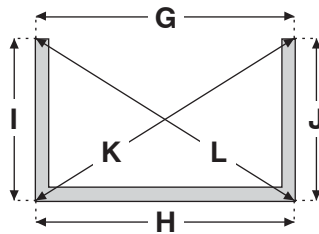

height of wall to top of roof sheeting

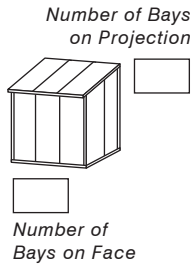

Minimum 2/12 pitch required for all glass & flat-glazed skylites.

Opening of Wall	
inches	
A	
B	
C	
D	
E	
F	
Curb Footing	
inches	
G	
H	
I	
J	
K	
L	
Other Dimensions	
inches	
M	
N	
O	
Roof Pitch	
inches	
" 12"	

Installation Situation

Standard

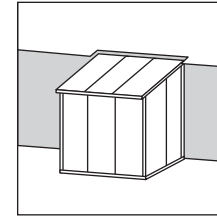

Corner w/ Roof Line

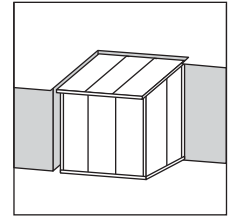

Use Page 1 for these Installations

Use Page 2 for these Installations

Corner

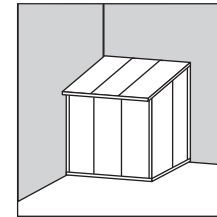

Skywall

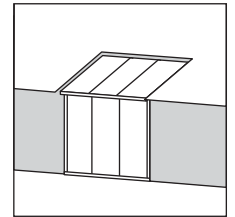

Vertical Glazing Type

Residential Commercial
Laminated or Polycarb. Glazing Required

Overhead Glazing Type

Residential Commercial
Laminated or Polycarb. Glazing Required



EVERETT
phone: 1-800-666-6065
fax: 425-258-6734

SPOKANE
phone: 1-800-382-5403
fax: 509-921-2137

SALEM
phone: 1-800-664-1257
fax: 503-391-0974

ADDITIONAL INFORMATION

Use this space to sketch out and list the dimensions of any information not mentioned on the previous page. This could include such items as glaze-in-openers, windows, doors, obstructions, etc...

Window Options

Insulated Glass Glazing Available Only

Awning

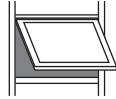

Insulated Glass Glazing Available Only

Single Hung

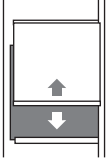

Insulated Glass Glazing Available Only

Casements

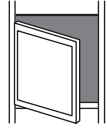

Door Options

Insulated Glass Glazing Available Only

Man Door

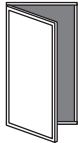

Insulated Glass Glazing Available Only

Patio Slider

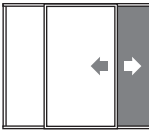

Insulated Glass Glazing Available Only

French Door

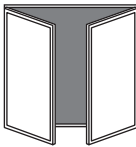

Specific Curb Make-Up

Use this space to sketch out and list the dimensions of the curb and any finishing associated with the curb.

Specific Wall Surface Make-Up

Use this space to sketch out and list the dimensions of the existing structure the sunroom or skywall will fasten to.

Specific Notations

Use this space to list critical items we should be aware of, such as: loading requirements, height restrictions, fall protection, and any other local requirements.

- Engineering Calculations Required

Opening Skylite Accessories

- Pre-Wire Frame
- Manual Opener
 - Truth Chain Drive
 - Hand Angle Drive
 - White
 - Bronze
 - Pole Straight Drive
 - Pole
 - 3'- 5'
 - 6'-10'
- Electric Opener
 - Truth HS (*remote standard*)



EVERETT
 phone: 1-800-666-6065
 fax: 425-258-6734

SPOKANE
 phone: 1-800-382-5403
 fax: 509-921-2137

SALEM
 phone: 1-800-664-1257
 fax: 503-391-0974