

Dealer / Location _____ Date _____

Contact / Phone _____ Quote Only
 Dealer PO

SUNROOM and SKYWALLS

opening at wall

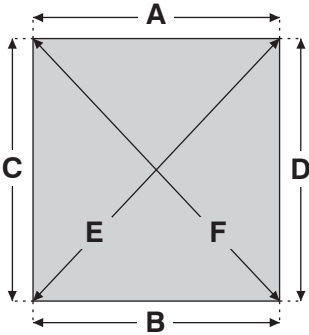

outside curb dimensions

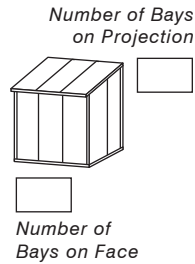
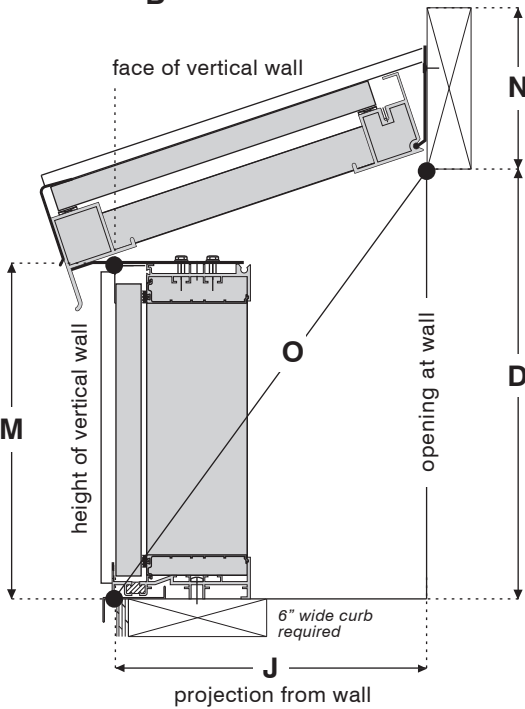
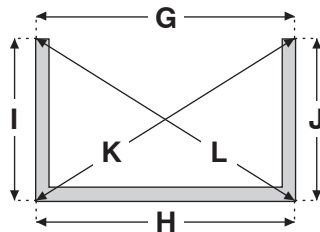

Minimum 2/12 pitch required for all glass & flat-glazed skylites.

Opening of Wall	
inches	
A	
B	
C	
D	
E	
F	
Curb Footing	
inches	
G	
H	
I	
J	
K	
L	
Other Dimensions	
inches	
M	
N	
O	
Roof Pitch	
inches	
_____ " 12"	

Installation Situation

Standard

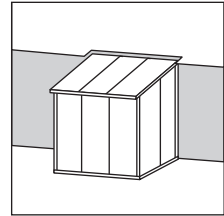

Corner w/ Roof Line

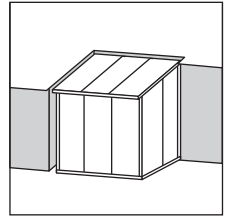

Use Page 1 for these Installations

Use Page 2 for these Installations

Corner

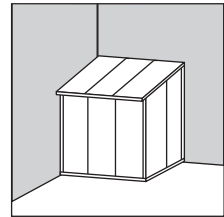

Skywall

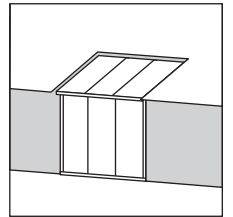

Vertical Glazing Type

Residential Commercial
Laminated or Polycarb. Glazing Required

Overhead Glazing Type

Residential Commercial
Laminated or Polycarb. Glazing Required

Dealer / Location

Date

Contact / Phone

- Quote Only
- Dealer PO

SUNROOM and SKYWALLS

opening at wall

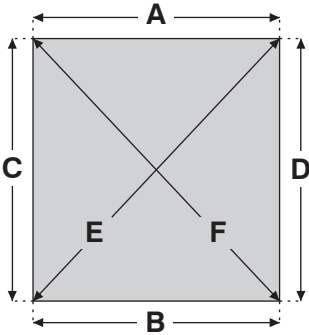

outside curb dimensions

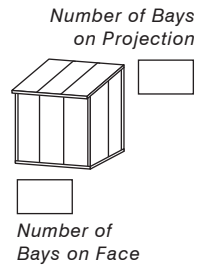
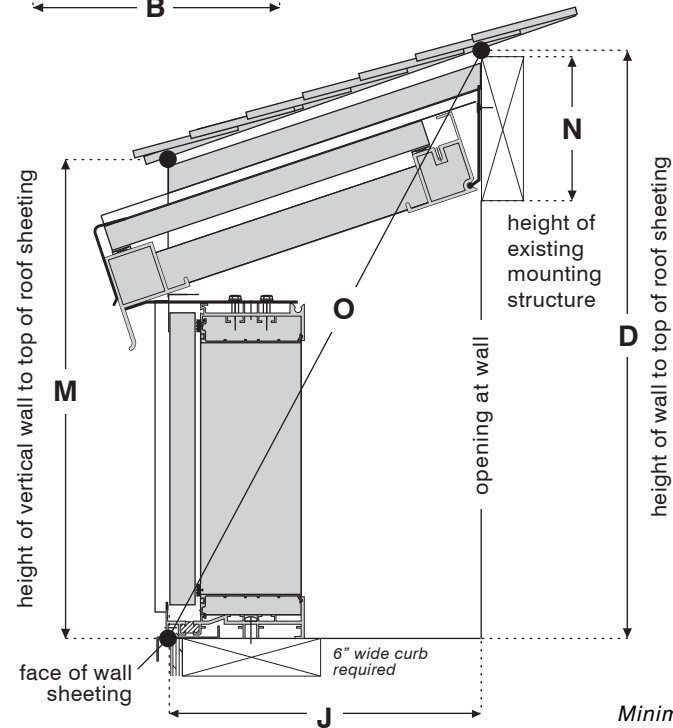
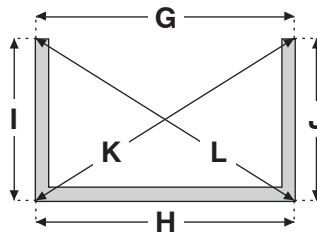

Minimum 2/12 pitch required for all glass & flat-glazed skylites.

Opening of Wall	
inches	
A	
B	
C	
D	
E	
F	
Curb Footing	
inches	
G	
H	
I	
J	
K	
L	
Other Dimensions	
inches	
M	
N	
O	
Roof Pitch	
inches	
_____" $\frac{12}{}$ "	

Installation Situation

Standard

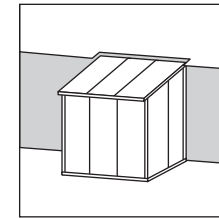

Corner w/ Roof Line

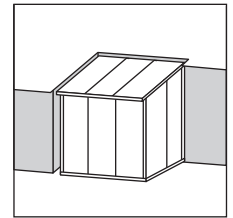

Use Page 1 for these Installations

Use Page 2 for these Installations

Corner

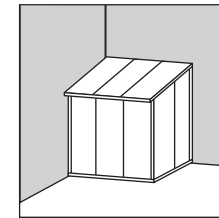

Skywall

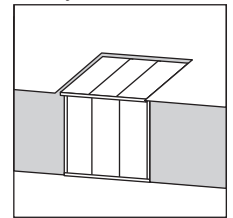

Vertical Glazing Type

- Residential Commercial
- Laminated or Polycarb. Glazing Required*

Overhead Glazing Type

- Residential Commercial
- Laminated or Polycarb. Glazing Required*

ADDITIONAL INFORMATION

Use this space to sketch out and list the dimensions of any information not mentioned on the previous page. This could include such items as glaze-in-openers, windows, doors, obstructions, etc...

Window Options

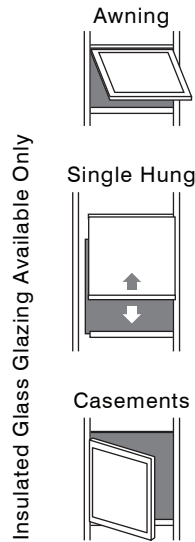

Door Options

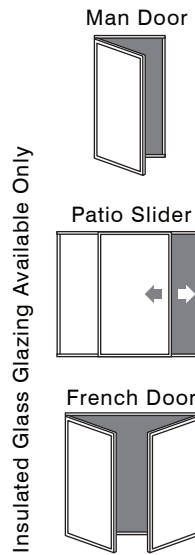

Specific Curb Make-Up

Use this space to sketch out and list the dimensions of the curb and any finishing associated with the curb.

Specific Wall Surface Make-Up

Use this space to sketch out and list the dimensions of the existing structure the sunroom or skywall will fasten to.

Specific Notations

Use this space to list critical items we should be aware of, such as: loading requirements, height restrictions, fall protection, and any other local requirements.

- Engineering Calculations Required

Opening Skylite Accessories

- Pre-Wire Frame
- Manual Opener
 - Truth Chain Drive
 - Hand Angle Drive
 - White Bronze
 - Pole Straight Drive
 - Pole
 - 3'- 5' 6'-10'
- Electric Opener
 - Truth HS (remote standard)