

**SERIES
4843**

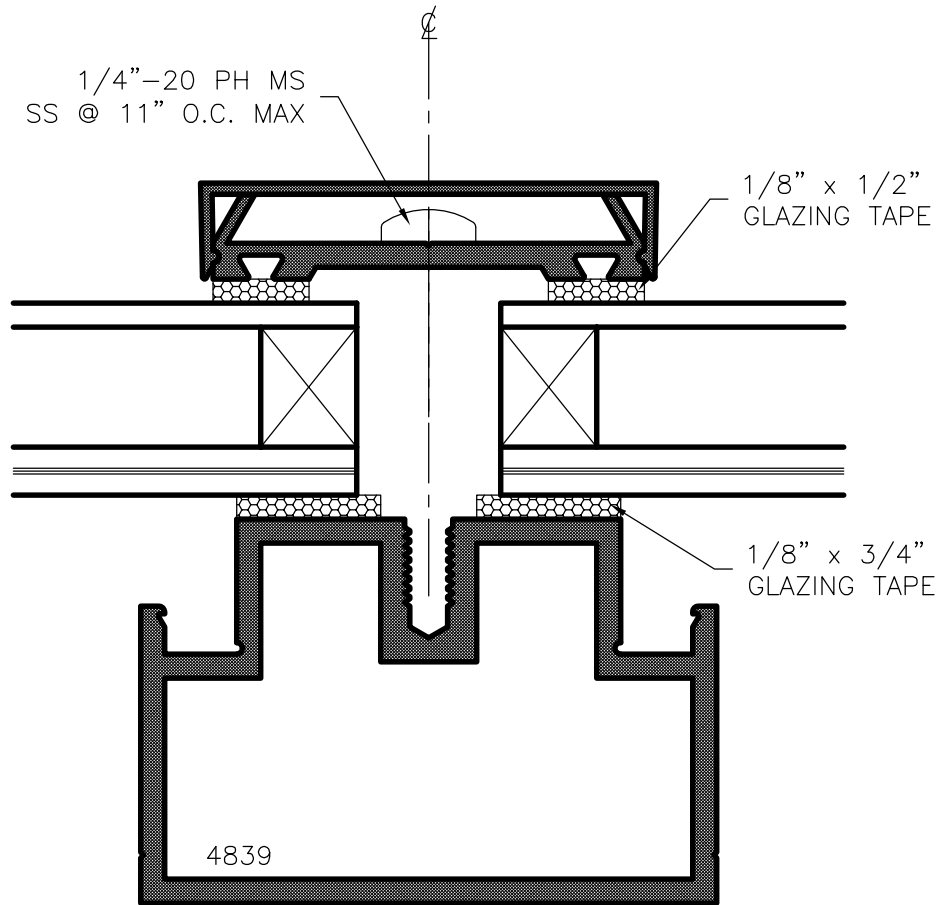

GENERIC GLAZING DETAILS.
ACTUAL DESIGN AND MAKE-UP VARY AS REQUIRED.

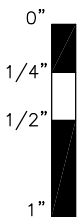

4839 Rafter

NAMI certified and rated by NFRC for thermal performance. Compliant to International Building Code; structural deflection limited to L/175 per ASTM E 330, air infiltration tested per ASTM E 283 at 6.24 psf, water penetration tested per ASTM E 331 at 30.00 psf.